

L6487EO TONIC C/E 800 ENC IC BRT/SIL CLEAR FT UK
 consists of: x1 - L6488EO TONIC C/E 800 DR RH IC BRT/SIL CLEAR FT UK (Pack 2/2)
 x1 - L6489EO TONIC C/E 800 DR LH IC BRT/SIL CLEAR FT UK (Pack 1/2)

L6490EO TONIC C/E 800 ENC IC BRT/SIL CLEAR UP UK
 consists of: x1 - L6491EO TONIC C/E 800 DR RH IC BRT/SIL CLEAR UP UK (Pack 2/2)
 x1 - L6492EO TONIC C/E 800 DR LH IC BRT/SIL CLEAR UP UK (Pack 1/2)

L6493EO TONIC C/E 900 ENC IC BRT/SIL CLEAR FT UK
 consists of: x1 - L6494EO TONIC C/E 900 DR RH IC BRT/SIL CLEAR FT UK (Pack 2/2)
 x1 - L6495EO TONIC C/E 900 DR LH IC BRT/SIL CLEAR FT UK (Pack 1/2)

L6496EO TONIC C/E 900 ENC IC BRT/SIL CLEAR UP UK
 consists of: x1 - L6497EO TONIC C/E 900 DR RH IC BRT/SIL CLEAR UP UK (Pack 2/2)
 x1 - L6498EO TONIC C/E 900 DR LH IC BRT/SIL CLEAR UP UK (Pack 1/2)

L6499EO TONIC C/E 1000 ENC IC BRT/SIL CLEAR FT UK
 consists of: x1 - L6500EO TONIC C/E 1000 DR RH IC BRT/SIL CLEAR FT UK (Pack 2/2)
 x1 - L6501EO TONIC C/E 1000 DR LH IC BRT/SIL CLEAR FT UK (Pack 1/2)

Tonic UK Instruction Number: 4954

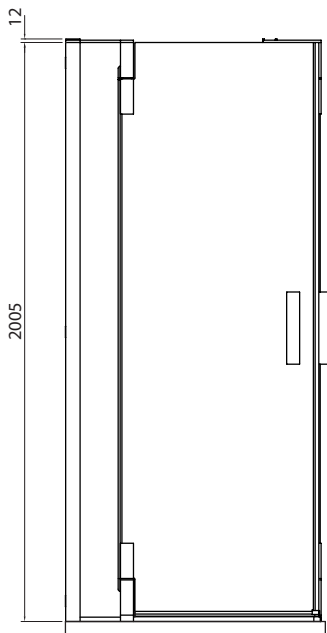
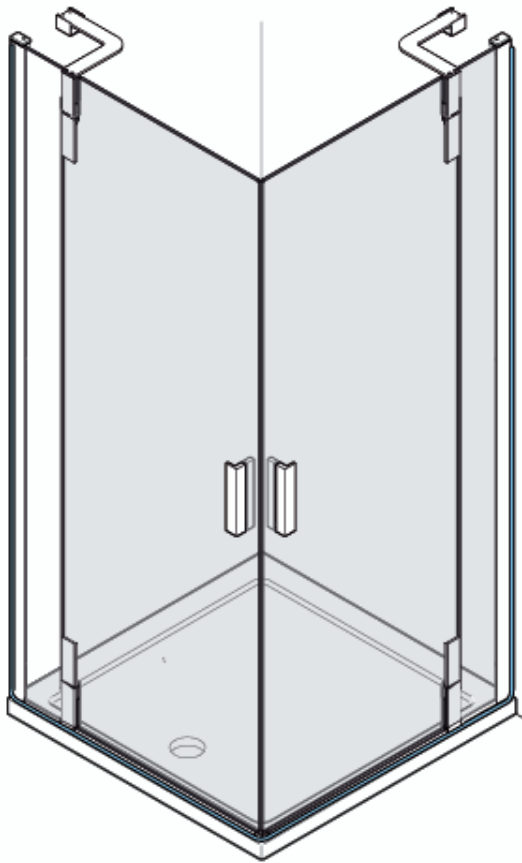

ENCLOSURE	DIM. A WIDTH (mm)	DIM. B OPENING (mm)	DIM. C REACH (mm)	DIM. D WIDTH (mm)	TRAY TYPE
800	773-793	807	577	773-793	FT
900	873-893	949	677	873-893	FT
1000	973-993	1019	727	973-993	FT
800	758-778	790	562	758-778	UP
900	858-878	930	662	858-878	UP

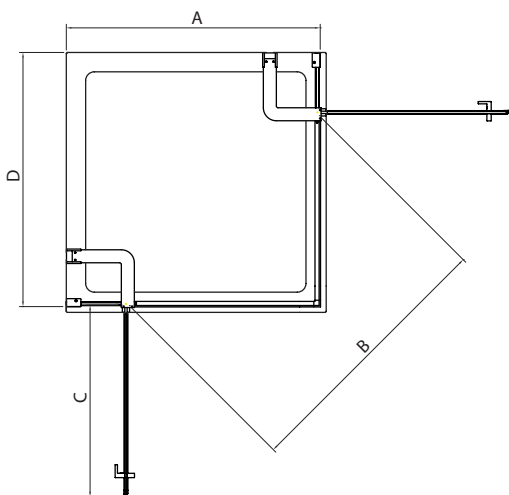

FT = FLAT TOP

UP = UPSTAND

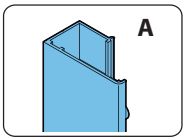

LV100EO

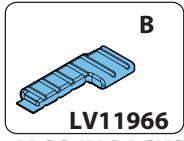

LV11966

ALSO IN PACKS
LV204AA & LV205AA

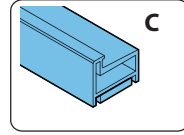

cut to
(800 FT) LV106EO 544mm
(900 FT) LV107EO 644mm
(1000 FT) LV107EO 694mm
(800 UP) LV106EO 524mm
(900 UP) LV107EO 624mm

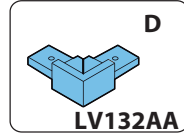

LV132AA

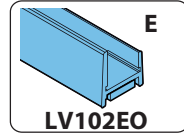

LV102EO

cut to
(800 FT) 144mm
(900 FT) 144mm
(1000 FT) 194mm
(800 UP) 144mm
(900 UP) 144mm

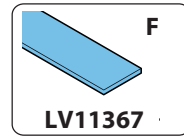

LV11367

cut to
(800 FT) 144mm
(900 FT) 144mm
(1000 FT) 194mm
(800 UP) 144mm
(900 UP) 144mm

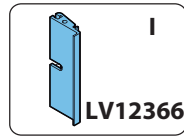

LV12366

ALSO IN PACKS
LV204AA & LV205AA

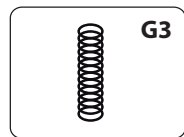

G3

SUPPLIED IN PACKS
LV20866 & LV21066

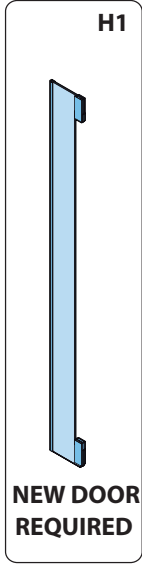

H1

NEW DOOR
REQUIRED

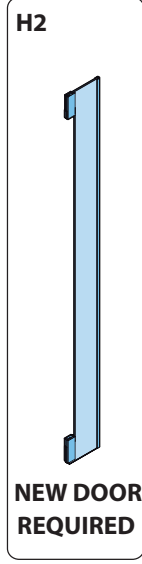

H2

NEW DOOR
REQUIRED

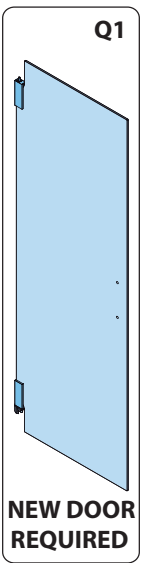

Q1

NEW DOOR
REQUIRED

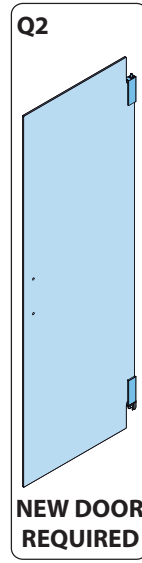

Q2

NEW DOOR
REQUIRED



No. 8x35



IN
PACKS
LV204AA
LV205AA
LV20667



No. 4x6



LV13567

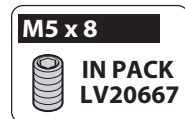

M5 x 8



IN PACK
LV20667



LV204AA
LV205AA
LV20667



Washer

SUPPLIED IN PACKS
LV204AA & LV205AA



4.5x12



LV12667

ALSO IN PACKS
LV204AA
LV205AA



3,5x15



LV12967

ALSO IN PACKS
LV204AA & LV205AA



Gasket

LV18667



M4 x 15



IN
PACK
LV20667

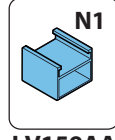

N1

LV159AA

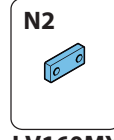

N2

LV160MY

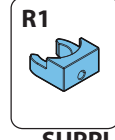

R1

SUPPLIED IN PACKS
LV20866 & LV21066

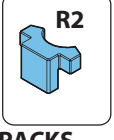

R2

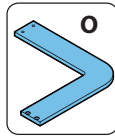

O

(800 FT/UP) LV163AA
(900 FT/UP) LV163AA
(1000 FT/UP) LV164AA

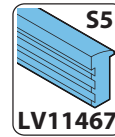

S5

LV11467



S6
RH
x1

LV23167

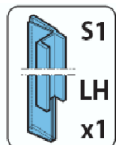

S1
LH
x1

LV11667

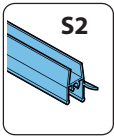

S2

LV11567

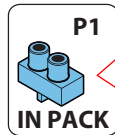

P1

IN PACK
LV20866

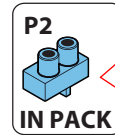
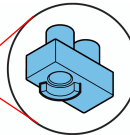

P2

IN PACK
LV21066

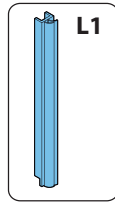
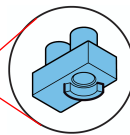

L1

LV15367

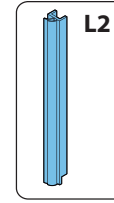

L2

LV15467



S3

LV11767



S4

LV11867



L7

IN PACK
LV20966



L8

IN PACK
LV21166



T2

LV13867



T1

LV13967

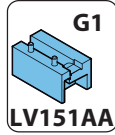

G1

LV151AA

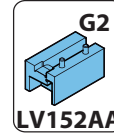

G2

LV152AA



U

LV101EO

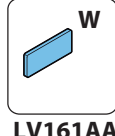

W

LV161AA



V1

LV127AA
ALSO IN PACK
LV204AA



V2

LV128AA
ALSO IN PACK
LV205AA

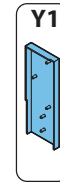

Y1

LV201AA

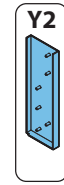

Y2

LV199AA

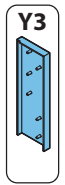

Y3

LV199AA

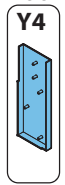

Y4

LV200AA

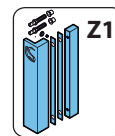

Z1

LV202AA

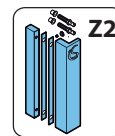

Z2

LV203AA

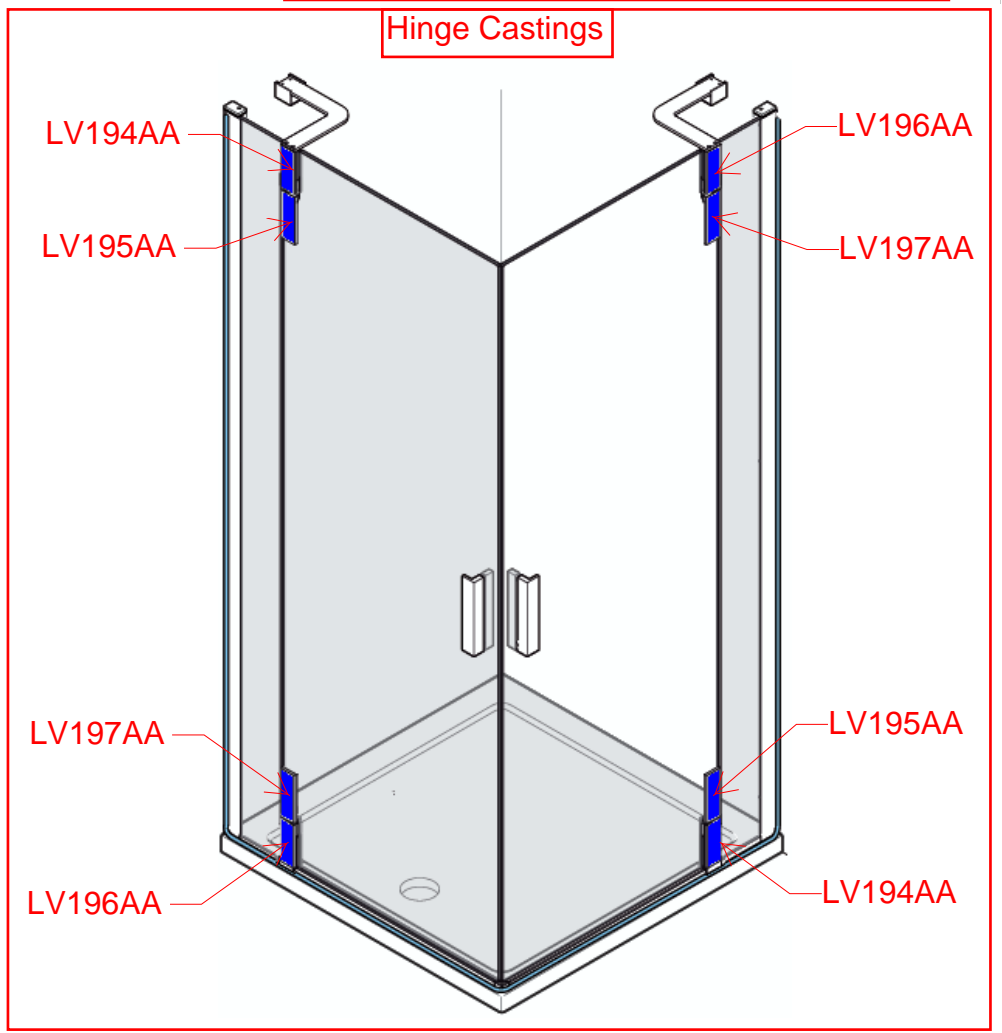
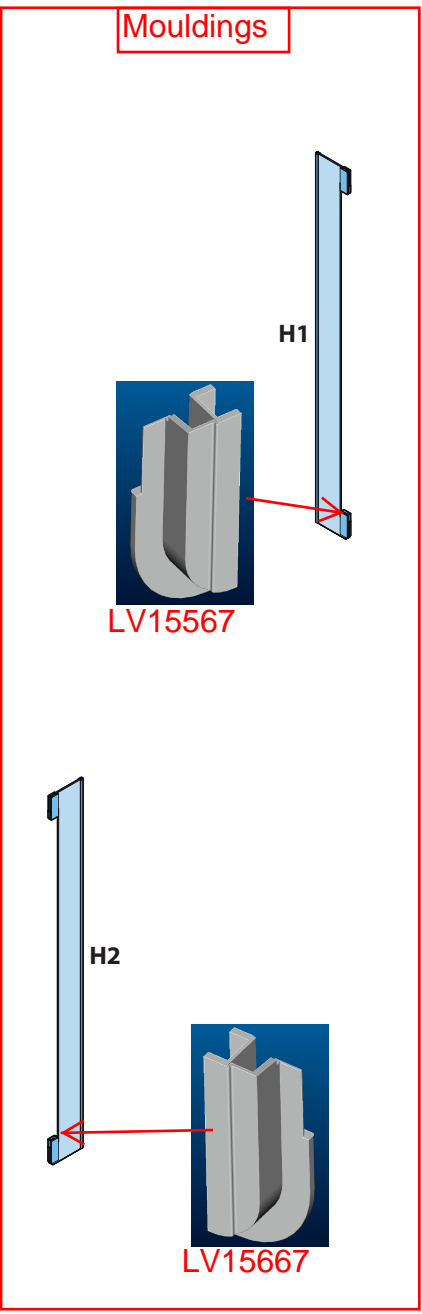
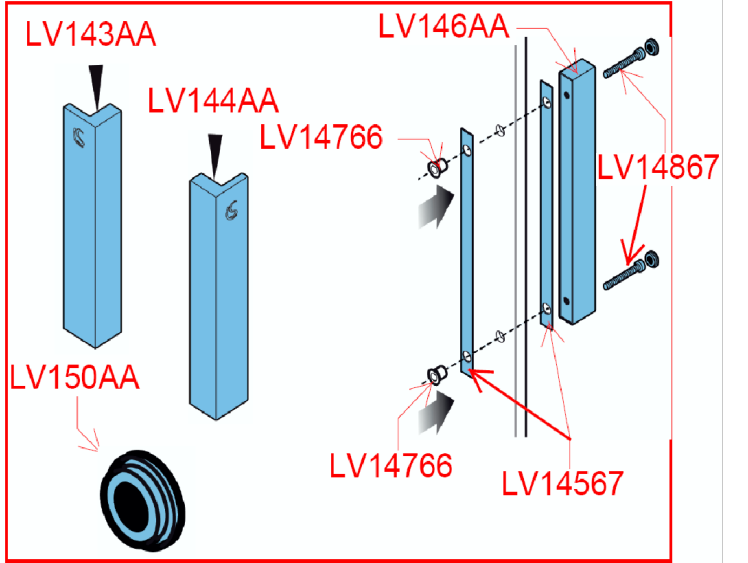
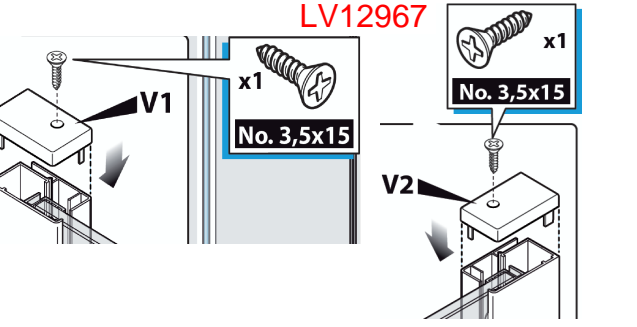
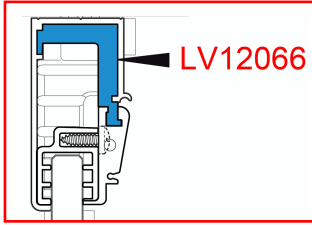
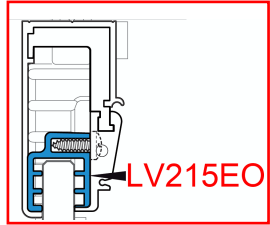
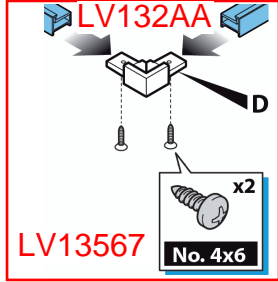
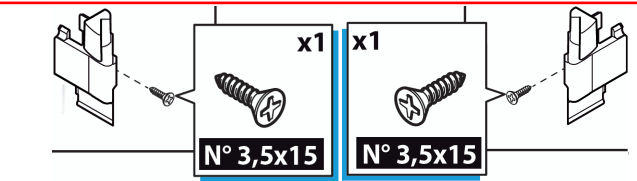
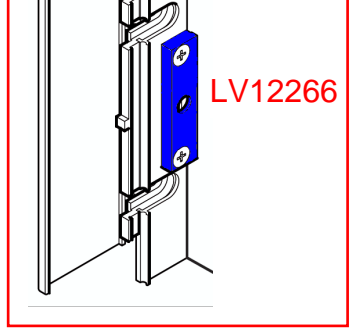
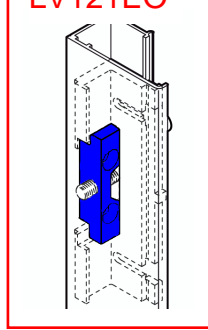
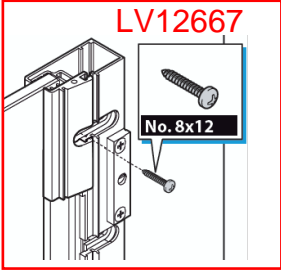
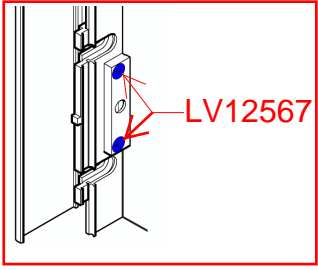
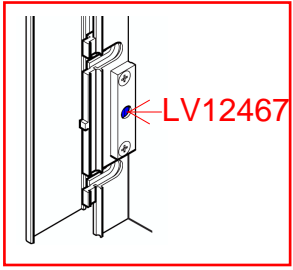

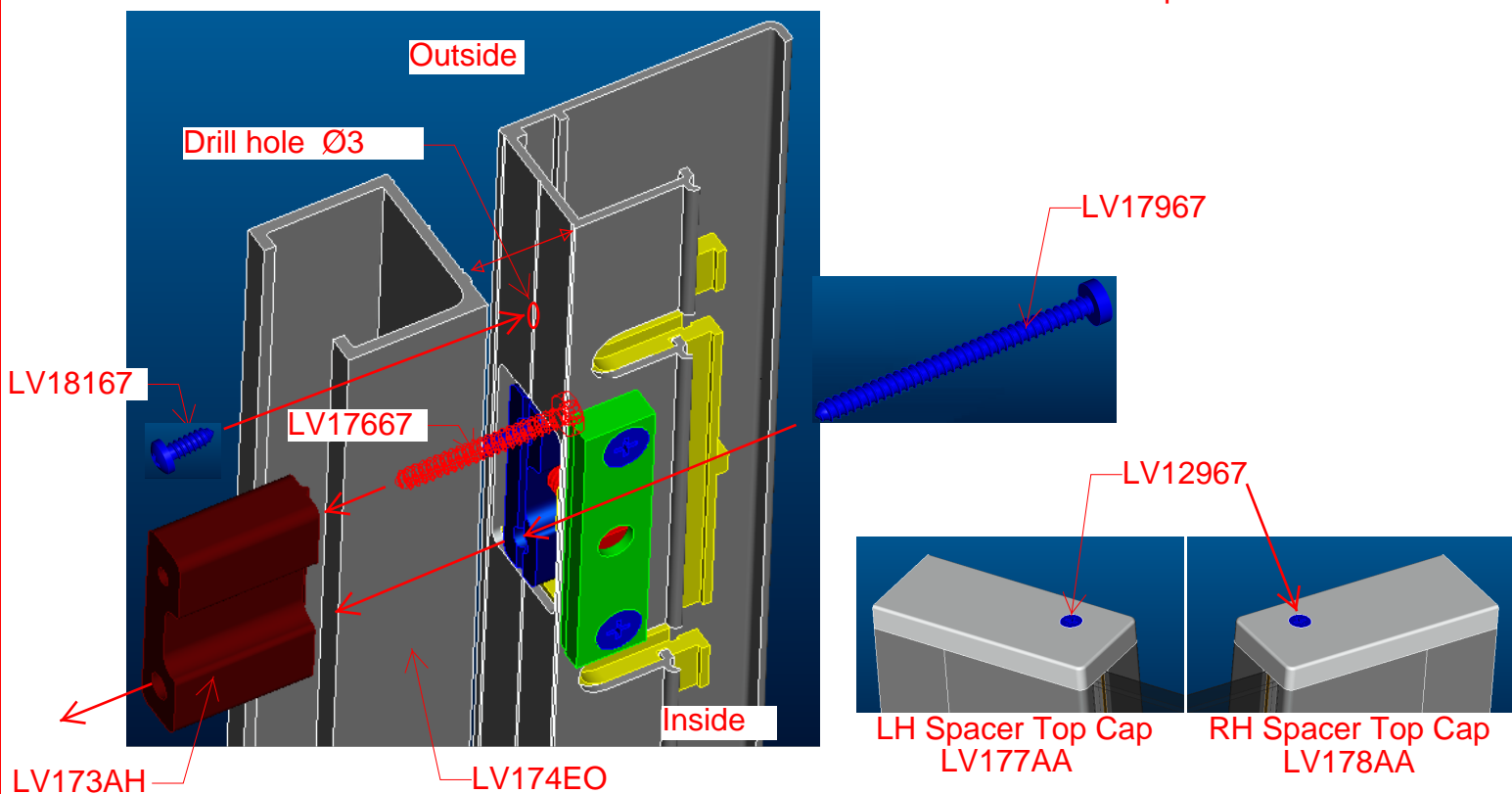

Ref.	Description	Spares Part No.	Ref.	Description	Spares Part No.
A	Wall Profile	LV100EO	N2	Wall Boss Clamp	LV160MY
B	Location Moulding (also in packs LV204AA, LV205AA)	LV11966	O	Wall Bracket (2) (used for 800 & 900 Corner Entry enclosures)	LV163AA
C	Door Bottom Rail Profile - 600mm (used for 800 FT enclosure - cut down to 544mm) (used for 800 UP enclosure - cut down to 524mm)	LV106EO	O	Wall Bracket (3) (used for 1000 Corner Entry enclosures)	LV164AA
C	Door Bottom Rail Profile - 750mm (used for 900 FT enclosure - cut down to 644mm) (used for 900 UP enclosure - cut down to 624mm) (used for 1000 FT enclosure - cut down to 694mm)	LV107EO	P1	Top Cam Blanking Moulding LH	in pack (LV20866)
D	Corner Entry Join Moulding	LV132AA	P2	Top Cam Blanking Moulding RH	in pack (LV21066)
E	Fixed Panel Bottom Rail Profile - 300mm (used for 800 FT/UP enclosure - cut down to 144mm) (used for 900 FT/UP enclosure - cut down to 144mm) (used for 1000 FT enclosure - cut down to 194mm)	LV102EO	Q1	LH Door c/w hinges	(new pack required)
F	Infill Sliding Seal - 910mm (used for 800 FT/UP enclosure - cut down to 144mm) (used for 900 FT/UP enclosure - cut down to 144mm) (used for 1000 FT enclosure - cut down to 194mm)	LV11367	Q2	RH Door c/w hinges	(new pack required)
G1	Bottom Rail Moulding LH	LV151AA	R1	Retainer Clip	in packs:(LV20866 & LV21066)
G2	Bottom Rail Moulding RH	LV152AA	R2	Door Stop Insert	in packs:(LV20866 & LV21066)
G3	Pivot Pin Spring in packs:(LV20866 & LV21066)		S1	Door Vertical Seal	LV11667
H1	LH Infill Panel c/w hinges (new pack required)		S2	Pivot Door Bottom Seal - 733mm	LV11567
H2	RH Infill Panel c/w hinges (new pack required)		S3	45degree Magnet Seal N-S	LV11767
I	Adjuster Connector also supplied in packs: (LV204AA & LV205AA)	LV12366	S4	45degree Magnet Seal S-N	LV11867
L1	Door Seal A	LV15367	S5	Infill Glazing Seal - 910mm	LV11467
L2	Door Seal B	LV15467	T1	Corner Entry Corner Seal Moulding RH	LV13967
L7	Bottom Cam Moulding A - LH in pack (LV20966)		T2	Corner Entry Corner Seal Moulding LH	LV13867
L8	Bottom Cam Moulding A - RH in pack (LV21166)		U	Cover Profile	LV101EO
N1	Wall Boss	LV159AA	V1	LH Top Cap Moulding also supplied in pack (LV204AA)	LV127AA
			V2	RH Top Cap Moulding also supplied in pack (LV205AA)	LV128AA
			W	Wall Boss Cover Cap	LV161AA
			Y1	Panel Retainer RH Cover Moulding	LV201AA
			Y2	Door Retainer LH Cover Moulding	LV198AA
			Y3	Door Retainer RH Cover Moulding	LV199AA
			Y4	Panel Retainer LH Cover Moulding	LV200AA
			Z1	LH Handle Assembly	LV202AA
			Z2	RH Handle Assembly	LV203AA

LV20866 Top LH Hinge Components Pack		
Qty	Description	Ref
(x1)	Infill Hinge Gasket A	
(x1)	Pivot Panel Moulding/Casting Retainer Moulding	
(x4)	M6 X 15MM CSK SET SCREW	
(x1)	Top Cam Blanking Moulding LH	P1
(x1)	Door Hinge Gasket A	
(x1)	Pivot Pin Sleeve Moulding	
(x1)	Pin Release Moulding	
(x1)	Hinge Pivot Pin	
(x2)	Pivot Pin Spring 8 0/D x 0.92 wire x 37.9 freelength (16.5solidlength)	G3
(x1)	Door Stop Insert	R2
(x1)	Pivot Door Moulding/Casting Retainer Moulding	
(x1)	Retainer Clip	R1

LV20966 Bottom LH Hinge Components Pack		
Qty	Description	Ref
(x1)	Infill Hinge Gasket B	
(x1)	Pivot Panel Moulding/Casting Retainer Moulding	
(x4)	M6 X 15MM CSK SET SCREW	
(x1)	Bottom Cam Moulding A - LH	L7
(x1)	Door Hinge Gasket B	
(x1)	M4 x 4mm Pointed Grub Screw	
(x1)	Hinge Bung	
(x1)	Hinge Pivot Pin	
(x1)	Bottom Cam Moulding	
(x1)	Pivot Door Moulding/Casting Retainer Moulding	

LV21066 Top RH Hinge Components Pack		
Qty	Description	Ref
(x1)	Infill Hinge Gasket B	
(x1)	Pivot Panel Moulding/Casting Retainer Moulding	
(x4)	M6 X 15MM CSK SET SCREW	
(x1)	Top Cam Blanking Moulding RH	P2
(x1)	Door Hinge Gasket B	
(x1)	Pivot Pin Sleeve Moulding	
(x1)	Pin Release Moulding	
(x1)	Hinge Pivot Pin	
(x2)	Pivot Pin Spring 8 0/D x 0.92 wire x 37.9 freelength (16.5solidlength)	G3
(x1)	Door Stop Insert	R2
(x1)	Pivot Door Moulding/Casting Retainer Moulding	
(x1)	Retainer Clip	R1

LV21166 Bottom RH Hinge Components Pack		
Qty	Description	Ref
(x1)	Infill Hinge Gasket A	
(x1)	Pivot Panel Moulding/Casting Retainer Moulding	
(x4)	M6 X 15MM CSK SET SCREW	
(x1)	Bottom Cam Moulding A - RH	L8
(x1)	Door Hinge Gasket A	
(x1)	M4 x 4mm Pointed Grub Screw	
(x1)	Hinge Bung	
(x1)	Hinge Pivot Pin	
(x1)	Bottom Cam Moulding	
(x1)	Pivot Door Moulding/Casting Retainer Moulding	

LV204AA LH Wall Fixing Pack		
Qty	Description	Ref
(x3)	No. 8 x 35mm Pan Phil A2 S/Tapper	
(x3)	Wall Plugs to suit No. 8 x 35 Screw	
(x1)	Location Moulding	B
(x3)	Adjuster Connector	I
(x3)	No. 8 x 1/2" Pan Phil A2 S/Tapper	
(x1)	LH Top Cap Moulding	V1
(x1)	No. 6 x 5/8" CSK Phil A2 S/Tapper	
(x3)	M5 Washer Fan Disc Type St/St	

LV205AA RH Wall Fixing Pack		
Qty	Description	Ref
(x3)	No. 8 x 35mm Pan Phil A2 S/Tapper	
(x3)	Wall Plugs to suit No. 8 x 35 Screw	
(x1)	Location Moulding	B
(x3)	Adjuster Connector	I
(x3)	No. 8 x 1/2" Pan Phil A2 S/Tapper	
(x1)	RH Top Cap Moulding	V2
(x1)	No. 6 x 5/8" CSK Phil A2 S/Tapper	
(x3)	M5 Washer Fan Disc Type St/St	

LV20667 Wall Bracket Fixing Pack		
Qty	Description	
(x2)	No. 8 x 35mm Pan Phil A2 S/Tapper	
(x2)	Wall Plugs to suit No. 8 x 35 Screw	
(x2)	M5 x 8mm Socket Grub Screw Flat Bottom	
(x2)	M4 x 15mm Socket Head CSK Screw	

LV216E0 Tonic Spacer Pack		
Qty	Description	
(x1)	Wall Fixing Extension Profile (XP0756B)	
(x3)	Wall Fixing Extension	
(x3)	No. 6 x 30mm Pan Phil A2 S/Tapper	
(x3)	No. 8 x 60mm Pan Head Screw	
(x1)	Spacer Top Cap Moulding LH	
(x1)	Spacer Top Cap Moulding RH	
(x4)	No. 6 x 12mm Pan Head Screw	
(x1)	No. 6 x 16mm CSK Screw	